

How Zhaga Book 20 and D4i can help you win the DoE L-Prize

Details of how Zhaga Book 20 and D4i can contribute to a successful L-Prize submission will be explained in the webinar presented jointly by the Zhaga Consortium and the DALI Alliance

Webinar: 19th August 2021

Welcome to the webinar

- Presentations will last for 40-45 minutes
- Followed by a Q&A session
- Please type questions into the “Q&A” box on your screen
 - Please DON'T use the chat box for questions
 - Don't include company sensitive information
- Presentation materials and a webinar recording will be available **after the event**:
 - <https://www.zhagastandard.org/books/overview/smart-interface-between-indoor-luminaires-and-sensing-communication-modules-20.html>
 - www.dali-alliance.org/events

Agenda

- **Welcome**
 - Paul Drosihn, General Manager DALI Alliance
- **Introduction to the L-prize**
 - Gabe Arnold, Senior Engineer, Pacific Northwest National Laboratory – PNNL
- **DALI Alliance**
 - Scott Wade, Technical Manager DALI Alliance
- **Zhaga**
 - Adrian Green, Amphenol, Chair Zhaga Working Group Book 20
- **Q+A**
- **Close**



L•PRIZE[®]

U.S. Department of Energy

L•PRIZE®

U.S. Department of Energy

\$12M
Prize Pool

3 PHASES:

- Concept
 - Prototype
 - Manufacturing & Installation
- + Teaming Opportunities

✉ LPrize@nrel.gov
americanmadechallenges.org/lprize

L-Prize Phases and Awards



L-Prize Innovation Goals and Focus



Efficacy

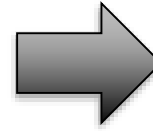

Increase lighting efficacy (lm/W) by 25 to 50% vs. today



Quality of Light

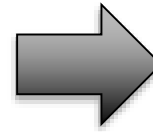

Encourage lighting that reinforces health, productivity, and well-being



Connectivity

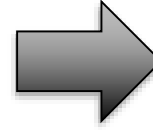

Integrate controls to increase energy savings and performance, enable grid flexibility



Product Life Cycle

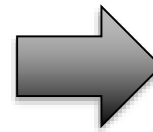

Reduce environmental impact over life cycle with sustainable use and end of life



Innovation and Inclusion

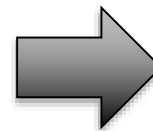

Realize innovation for diversity, equity, and inclusion

Consistent, Challenging Technical Requirements for All Phases

Efficacy	Quality of Light	Connectivity	Product Life Cycle	Innovation and Inclusion
<ul style="list-style-type: none">✓+☐ Luminaire efficacy	<ul style="list-style-type: none">✓ Chromaticity✓ Dimming range✓ Glare control✓ Light output✓ Spectral data reporting✓+☐ Color rendition✓+☐ Flicker☐ White-tunable	<ul style="list-style-type: none">✓ Interoperability✓ Addressability✓ Energy reporting✓ Lighting control strategies✓ Luminaire-level lighting control✓+☐ System resilience✓+☐ Fault detection and diagnostics✓+☐ Grid services capable☐ Sensor ready and upgradeable☐ Ease of install and configuration	<ul style="list-style-type: none">✓ Driver lifetime✓ Chromaticity Maintenance✓+☐ Replaceable components✓+☐ Lumen maintenance☐ Design for disassembly	<ul style="list-style-type: none">☐ Technical innovation☐ Innovation for diversity, equity, and/or inclusion
<p>Key</p> <ul style="list-style-type: none">✓ = Mandatory✓+☐ = Mandatory + Optional Points☐ = Optional Points Only				

L-Prize Scope and Target Applications

- Light-emitting diode (LED) technology
- Complete lighting system (luminaires, sensors, control devices, interfaces)
- Commercial and institutional sector applications
- Luminaires must be appropriate for ambient lighting in building interiors such as offices, healthcare facilities, educational facilities, and other applications where linear lighting has been predominant
- Luminaires designed or intended for task, accent, display, outdoor, and industrial applications including high/low bay are not eligible
- Specific form factors are not required — innovation is welcomed

Teaming Opportunities

- Some teams and innovators have already registered and are looking for partners. Check it out at: <https://www.herox.com/LPrize/teams>
- An RFI will be issued with the Prototype Phase and kept open to identify teaming partners interested in production and installation of winning designs
- A teaming partner list will be published and regularly updated
 - Manufacturing partners
 - ESCOs
 - Utilities
 - Installation contractors
 - Etc.



L•PRIZE®

U.S. Department of Energy

QUESTIONS?

www.heriox.com/LPrize/forum

Email: LPrize@nrel.gov

www.heriox.com/LPrize

www.americanmadechallenges.org/LPrize

How D4i and DALI-2 can help you win the L-Prize

Scott Wade, DALI Alliance

19th August 2021



Agenda

How D4i and DALI-2 can help you win the L-Prize

- Introduction: DALI, DALI-2, D4i and the DALI Alliance
- DALI parts helping L Prize criteria
- What is D4i?
- Testing & Certification



Scott Wade,
Technical &
Certification Manager,
DALI Alliance

DALI – The basics



Digital **A**ddressable **L**ighting **I**nterface

- DALI® is the industry-standard protocol (language) for bi-directional, digital communication between lighting-control devices.
 - Dedicated to lighting, with a rich feature set
- DALI is technically managed in the open, global standard IEC 62386.
- DALI-2™ is the latest version of the DALI protocol.
- DALI-2 and D4i certification is driven by DiiA, the global DALI alliance.
 - Ensures interoperability through testing and certification with trademark use
- DALI, DALI-2 and D4i trademarks are controlled by DiiA.



The DALI Alliance

- The DALI Alliance (DiiA) is an open, global consortium of lighting companies that aims to grow the market for lighting-control solutions based on DALI.
- Also known as  Digital Illumination Interface Alliance
- More than **290 members** worldwide.
 - Industry leaders in lighting and control
- Membership allows certification or registration of products:
 - Over **1,870 DALI-2 certified products (including D4i)**
 - Over 1,460 DALI version-1 registered products
- Membership allows DALI, DALI-2 and D4i **trademark use**.



DALI market

- Very large installed base of projects, spanning three decades
 - See www.dali-alliance.org/awards
 - Also www.dali-alliance.org/projects
- Used in major infrastructure projects
 - e.g. Crossrail in London, MTA New York City Transit, Manchester Airport and Beijing Airport
- DALI is “the **largest wired digital open protocol** in the world for lighting.”
 - *Pål Karlsen, research analyst, Omdia, LED Professional May/June 2020 issue, [Link](#)*
- “Open protocols will be the growth winners over the next few years in smart lighting and connected controls.”
 - *Ibid*
- “DALI is the **largest segment for smart lighting**, with **15% CAGR** expected over the next 5 years”
 - *Global Smart Lighting Market research report, [Link](#)*



Mapping D4i and DALI-2 to L-Prize criteria

The U.S. Department of Energy lists several areas that winning systems must meet.



D4i and DALI-2 help meet the criteria:

- **Efficacy (up to 10 points)**
 - **Wide dimming range + individual addressability:** get just the right amount of light in just the right places.
- **Quality of Light (up to 8 points)**
 - **Light output:** Part of the DALI specifications and tests, for all D4i and DALI-2 LED drivers.
 - **Colour:** DALI part 209 – from simple tunable white to full xy-chromaticity.
 - **Dimming range:** The DALI standard allows for dimming down to 0.1%. Check with the driver manufacturer.

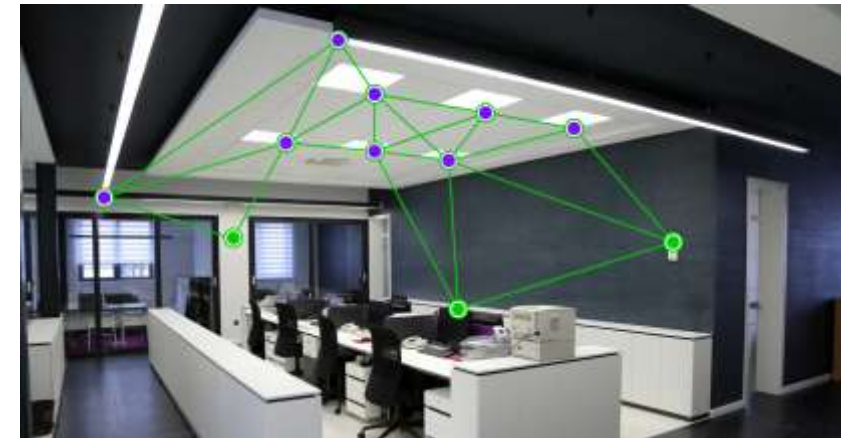

Mapping D4i and DALI-2 to L-Prize criteria

- **Connectivity (up to 11 points)**

- **Technical interoperability:** D4i and DALI-2 use international industry standards, with testing and certification, ensuring a high level of interoperability.
- **Application interoperability:** Standardised data available from D4i LED drivers.
- **Addressability:** D4i and DALI-2 drivers are individually addressable.
- **Energy reporting:** D4i drivers provide energy and power data.
- **Lighting control strategies:** All are supported.
- **System resilience:** Operation through power cycles, short power interruptions and bus failure is defined, configurable, and tested.

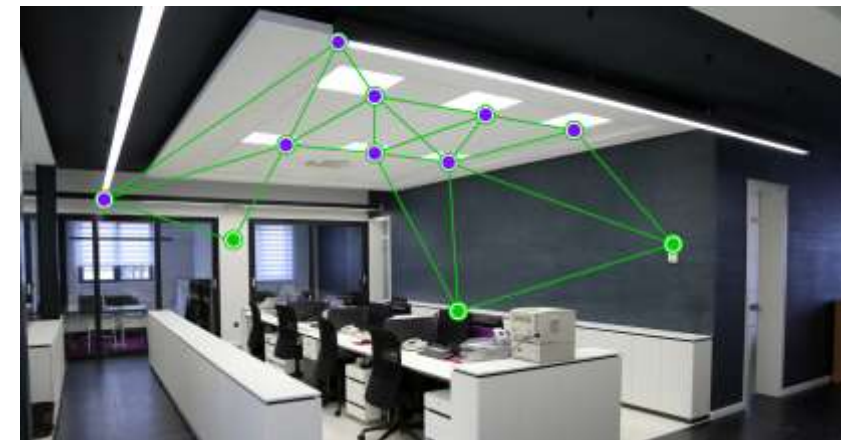

Mapping D4i and DALI-2 to L-Prize criteria

- **Connectivity (up to 11 points) - continued**
 - **Fault detection and diagnostics (FDD):** DALI-2 includes fundamental information, with D4i adding more.
 - **Luminaire level lighting control (LLLC):** D4i or DALI-2 sensors can be attached to individual luminaires. Addressability allows control of a single luminaire, a group of luminaires or all luminaires.
 - **Grid services capable:** Check with your supplier for suitable D4i or DALI-2 control devices that provide demand-response functionality.
 - **Sensor ready and upgradeable:** D4i luminaires are ready for sensors or communication devices to be plugged-in or upgraded.
 - **Ease of installation and configuration:** Simple 2-wire bus providing communications and power, that simply connects to all devices in parallel, using a daisy chain and/or star connections.

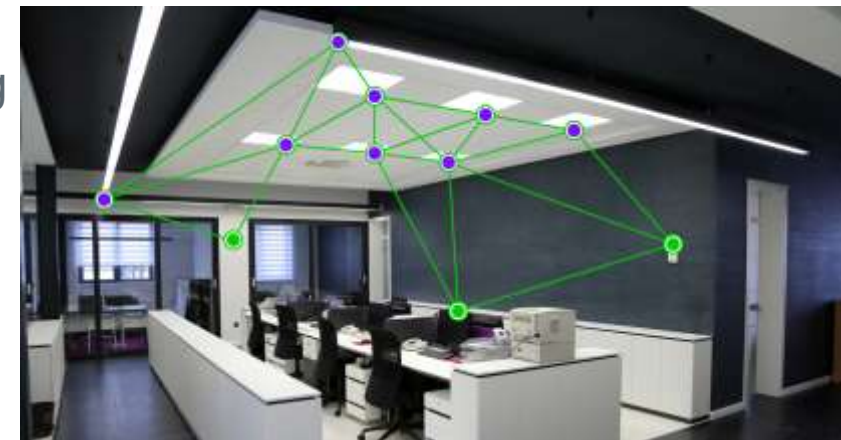

Mapping D4i and DALI-2 to L-Prize criteria

- **Product Life Cycle (up to 7 points)**
 - **Replaceable components:** Interoperability of drivers and control devices enables replacement by using appropriately specified components.
- **Innovation and Inclusion**
 - Initial cost minimised by allowing sensors/communication devices to be plugged-in later, if required.
 - Future: DALI-2 and D4i are still evolving, with new standards and certification being added. For example, centralized emergency lighting to complement the existing standardisation of DALI self-contained emergency lighting.

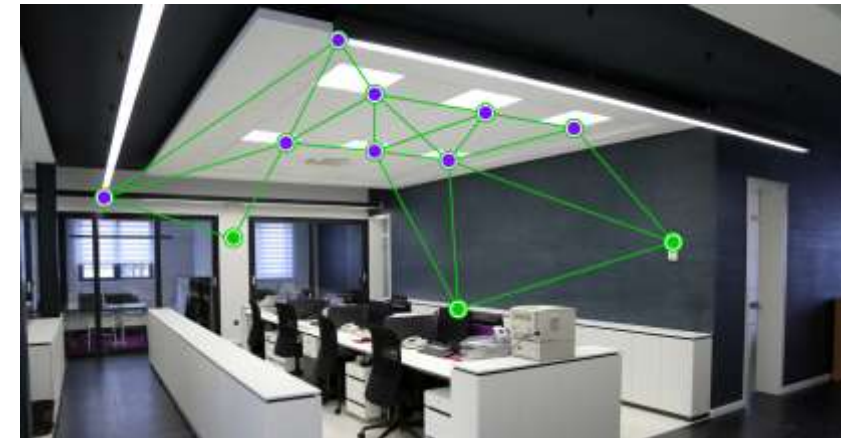

What is D4i?

D4i is an extension to DALI-2:

- Control gear (drivers) require a minimum set of functionality for D4i
- Control devices require functionality to aid “plug & play”
- Luminaires require up to four D4i drivers.
 - Especially for intra-luminaire use: DALI is inside the luminaire
- All D4i LED drivers provide luminaire, energy & diagnostics data
- D4i enables DALI inside intelligent, IoT-ready luminaires
 - Other D4i implementations are also permitted
- D4i simplifies addition of sensors and communication devices to luminaires
- D4i enables plug-and-play interoperability when combined with a connector system
 - e.g. Zhaga Book 18 & 20 or NEMA/ANSI C136.41



D4i example luminaire



DALI Part 250
(integrated bus power)

DALI Parts 251-3
(data for enhanced asset tracking & performance monitoring)

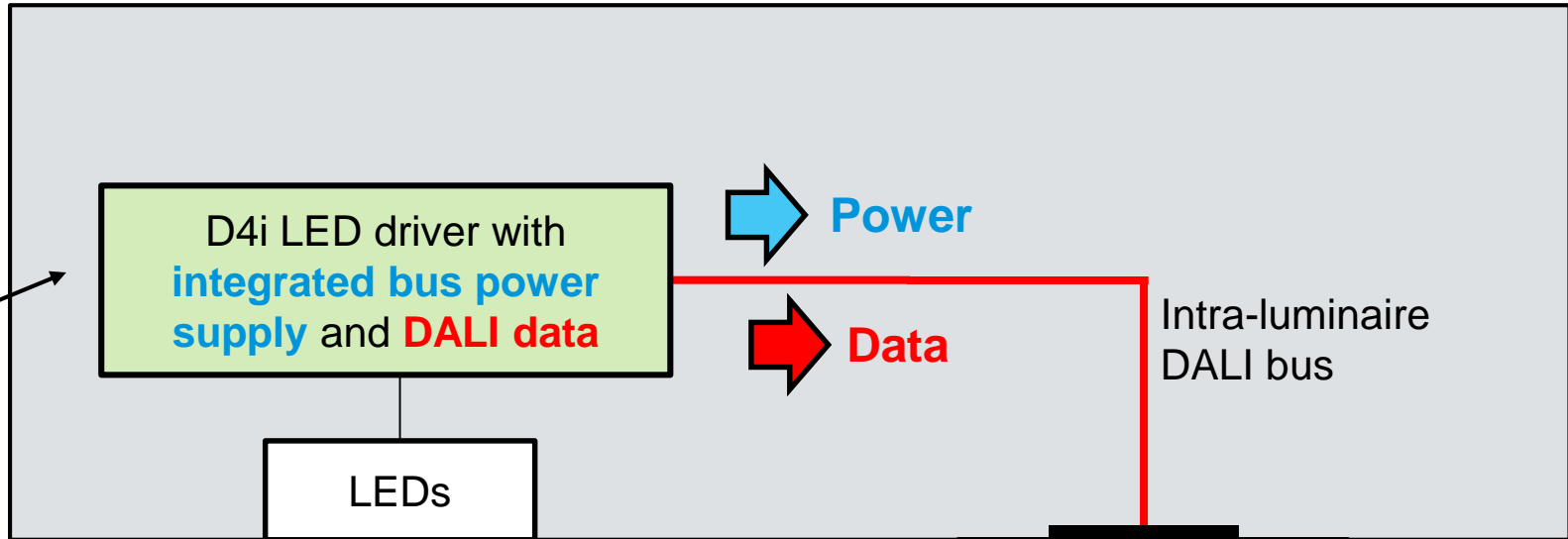

DALI Part 351
(luminaire-mounted control devices)

Data specifications



- Data for enhanced asset management & performance monitoring
- Data storage in DALI memory banks, with standardized format & locations



Luminaire Data



DALI Part 251 – Luminaire Data

- Information about the luminaire (e.g. GTIN, light output, CCT & CRI, light distribution etc) can be stored in the LED driver
- Enables asset management



Energy Data

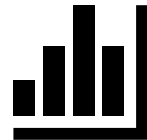

DALI Part 252 – Energy Reporting

- Provides real-time power & energy usage for LED drivers



Diagnostics Data



DALI Part 253 – Diagnostics & Maintenance

- Operating data for control gear and lamps, including failure conditions, run-time data
- Enables predictive maintenance

- **These specifications are available from DiiA, and are also included in ANSI C137.4.**

Using DALI data: Example



In the factory:
Luminaire data is programmed into drivers.



Network

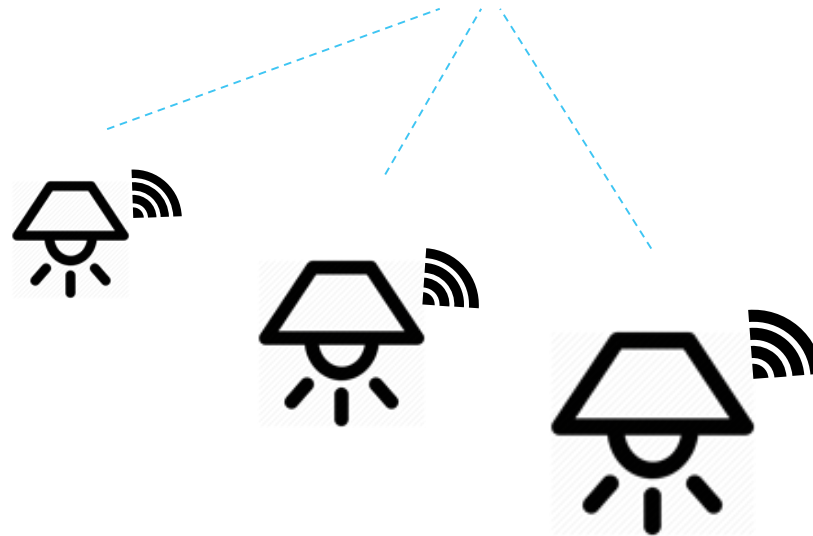

During operation:
Performance monitoring

- Energy usage data can be used e.g. for billing

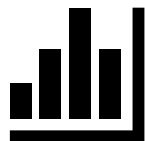

In the field:

Automated commissioning

- When installed, luminaires can automatically transfer data to a remote network
- Reduces human error, saves installation time and cost
- Operator has a full map of asset information

During operation:

Predictive maintenance

- Diagnostics data allows network operator to anticipate need for maintenance
- Repair team has knowledge of location and type of fixture



Testing & certification



DALI-2 and D4i products are tested and certified:

- **Testing**
 - Compliance testing may be carried out by the DALI Alliance member, or at an accredited test-house.
- **Test-houses**
 - Accredited test-houses are listed on the DALI Alliance website:
 - www.dali2.org/testing/test-houses.html



- **Certification**
 - Product information and test results are submitted to the DALI Alliance for verification, before D4i or DALI-2 certification is granted.
 - Once certification is granted, products are publicly listed on the website.

Product database

- All D4i and DALI-2 certified products are listed and searchable on the DALI Alliance website:
 - www.dali-alliance.org/products
- The product information shows if D4i certification was achieved in addition to DALI-2, and shows the specific parts of the standard that are implemented, such as luminaire data, power/energy and diagnostics data.

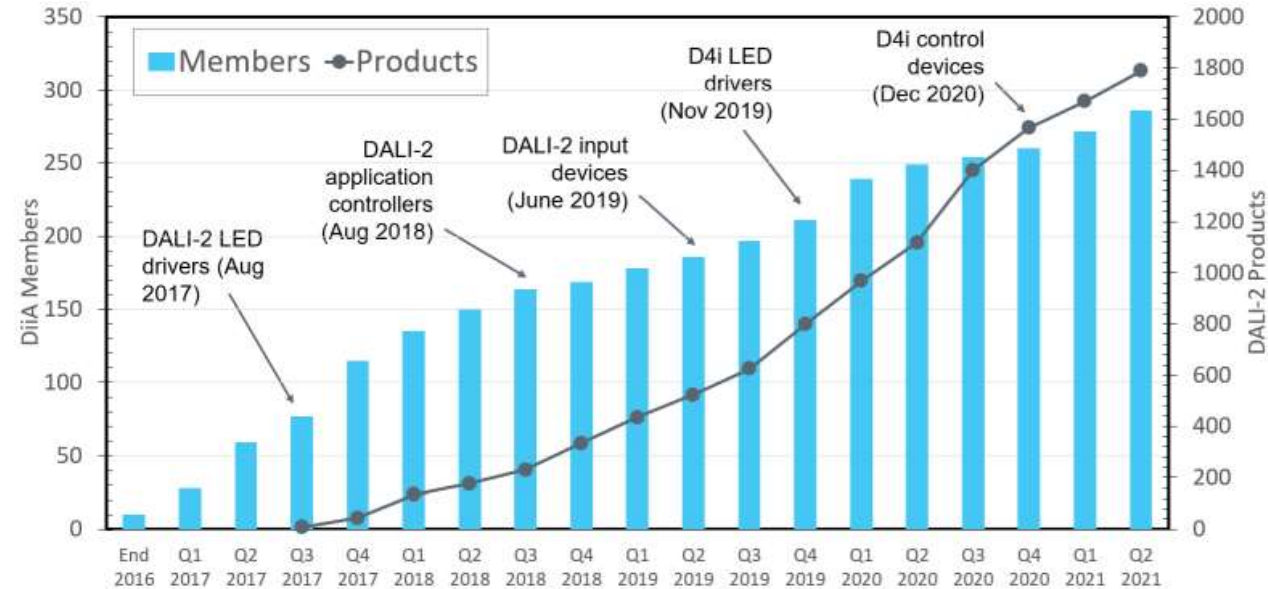

D4i and Zhaga–D4i certification

DALI Alliance members

Zhaga members

LED driver

D4i
certification
→



Control device

1
D4i
certification
→



2
Zhaga
certification
→

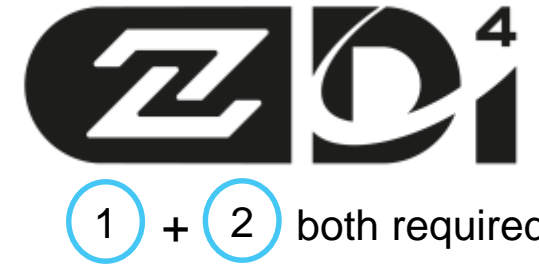

Luminaire

*Use of D4i
components*



Zhaga
certification
→



Connector

Zhaga
certification
→



Book 20
Smart interface between
indoor luminaire and
sensing/communication
modules

Aug 2021

The Zhaga Consortium



Market drivers and solution

Market requirement: Smart, future-proof LED luminaires easily upgradeable to keep pace with rapid developments in digital networking technology as one of the key requirements.

Solution: The Zhaga-D4i interface standard

- A simple way to add sensors and/or wireless communication modules to luminaires. Zhaga and DALI Alliance collaborate to develop and maintain a standardized interface between luminaires and sensor and/or communication modules
- Combination of complementary specifications for mechanical fit, digital communication and power supply for modules
- Zhaga-D4i certification to ensure full interoperability

Book 20: smart interface for indoor luminaires

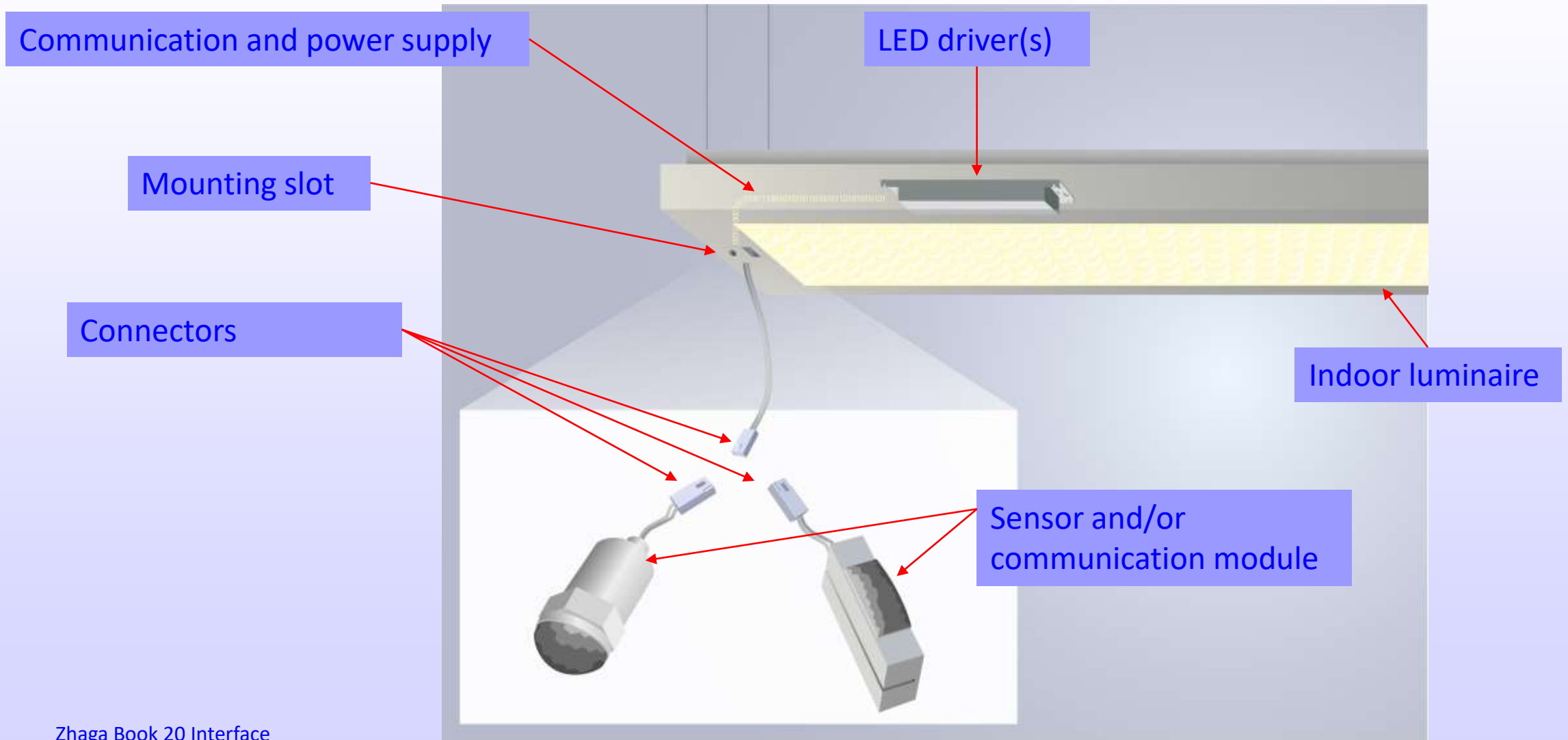

Features of Zhaga-D4i interface standard



- Easy to add or upgrade sensors and/or communication modules:
 - Enables future-proof luminaires that can keep pace with rapid developments in digital networking and sensing technology.
- Intra-luminaire DALI-2 bus:
 - Enables bi-directional communication between sensors and/or communication modules and LED drivers using the well-established and standardized DALI-2 protocol.
- D4i drivers are smart:
 - Able to report operational and diagnostic data to an external network, can provide inventory-related information about luminaires.
- IoT connectivity:
 - With a suitable wireless communication module, the luminaire is able to interact with an external lighting-control network and to become part of the IoT.

Complementary specifications in Zhaga and DALI Alliance



D4i specifications from DALI Alliance:

DALI Part 250: Integrated bus power supply

DALI Part 251: Luminaire data for asset management

DALI Part 252: Energy reporting for drivers

DALI Part 253: Diagnostics & maintenance data for drivers

DALI Part 351: Luminaire-mounted control devices



Book 20 specification from Zhaga:

- Mechanical interface between Module and luminaire
- Specified electrical connector
- Specification of luminaire's interface

Book 20 – fitting systems

Book 20 enables a number of fitting system appropriate for the application, including plug-and-play

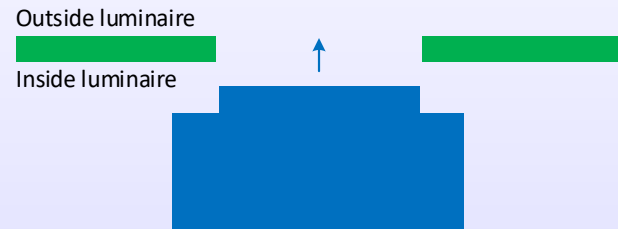

Module is mounted from the inside of the luminaire into the opening

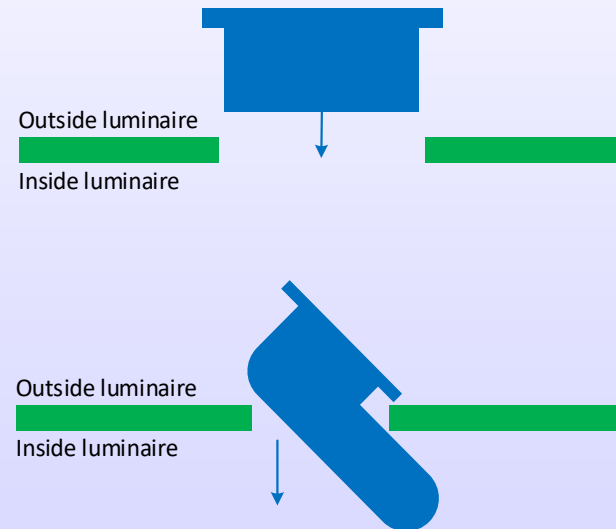

Module is mounted from the outside of the luminaire into the opening

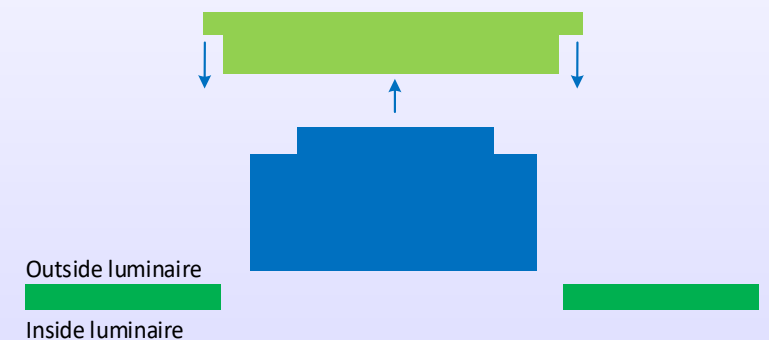

The module is mounted from the outside of the Luminaire by using a bracket

Categorized mechanical interfaces enable standardized and cost-effective, but flexible solutions

Five different categories for the mechanical interface facilitate dedicated luminaire- and module-designs:

- R44x17 (44 x 17 mm)
→ Rectangular modules with small volumes and indifferent orientation
- R60x22 (60 x 22 mm)
→ Rectangular modules requiring more volume and surface, e.g. gas detectors or complex pressure detectors
- C22-T1A (Ø 22 mm):
→ Cylindrical modules as already widely used in the field, adjustable orientation, minimum surface
- C22-T1B (Ø 22 mm):
→ Cylindrical modules as already widely used in the field, adjustable orientation, larger lenses
- C22-T2 (Ø 22 mm):
→ L-shaped modules enable ultraflat luminaire designs



Features of the Connector

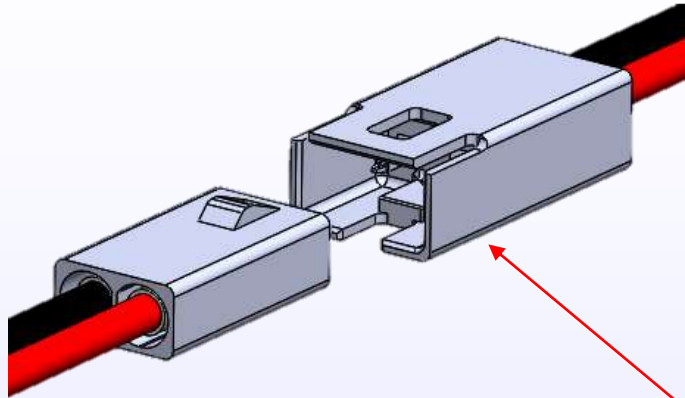

- Two position plug and receptacle interface:
 - Easy to use separable connection provides reliable DALI connectivity
- Poka Yoke features prevent incorrect mating.
 - Enables connection with polarity ensured
- Connector provides finger proof protection
 - Housing provides touch proof protection for separable contacts
- Plug & play functionality can be installed by a generalist
 - Does not require a specialist to upgrade luminaire functionality
- Integrated latch feature provides 5N minimum retention when mated
 - Slim profile latch ensures that connectors remain intact over its lifetime

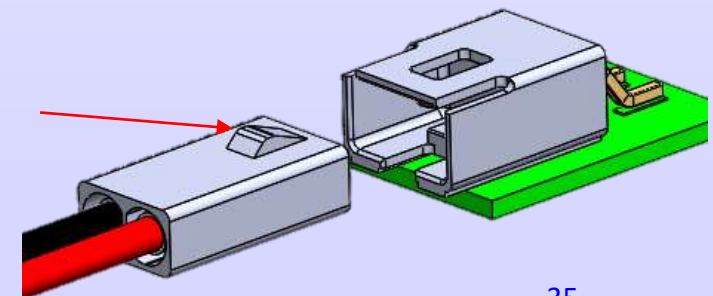
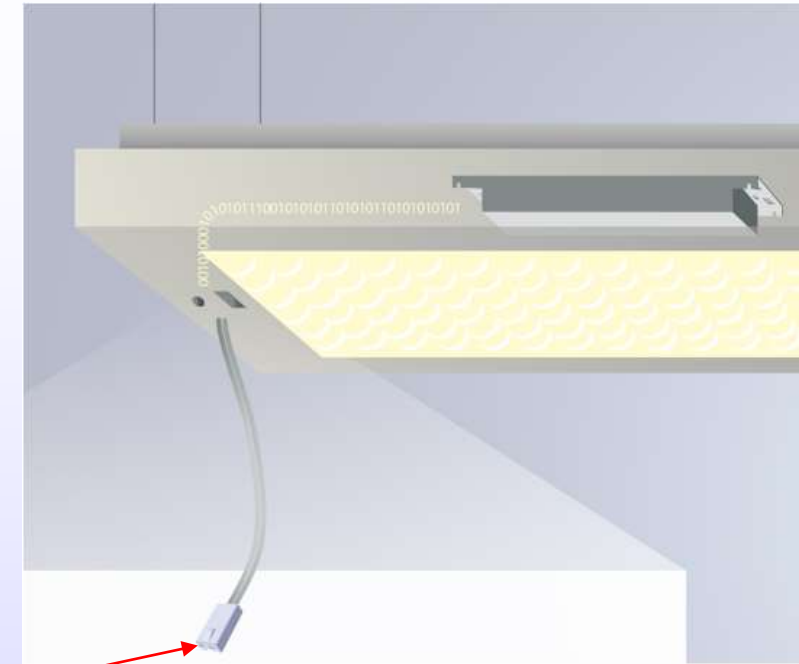

Zhaga-D4i certification



- **Zhaga-D4i certification:** A joint program from Zhaga and DALI Alliance
 - Certification of interoperable luminaires and sensing and/or communication modules
- Based on **complementary specifications** from Zhaga and DALI Alliance
 - Zhaga **Book 20** plus **D4i** specifications
- Product certification will allow for use of Zhaga and D4i logos
 - For **indoor luminaires, sensing and communication modules**
 - Logos indicate multi-vendor **product interoperability**
- LED drivers are eligible for D4i certification from DALI Alliance

Benefits of Zhaga-D4i certification

- Certification gives confidence for interoperability
 - Certification carried out by independent authority
 - Certified products are traceable in public databases
 - Certification logos are trademarked to prevent misuse
- Certification gives business advantages
 - Certified luminaires and components are available from multiple suppliers
 - Certification logos provide an established brand for product marketing
- Certification ensures that luminaires are future-proof and will be able to host next-generation Zhaga-D4i nodes



Scope of Zhaga-D4i certification



Zhaga-D4i Module



Zhaga and D4i logo

Certification by Zhaga, after D4i certification by DALI Alliance

Zhaga-D4i Luminaire



Zhaga and D4i logo

Certification issued by Zhaga

D4i Driver



D4i logo

Certification issued by DALI Alliance (includes DALI-2 certification)

Zhaga Book 20 Connector



Zhaga logo

Certification issued by Zhaga

Zhaga-D4i certification for indoor luminaires

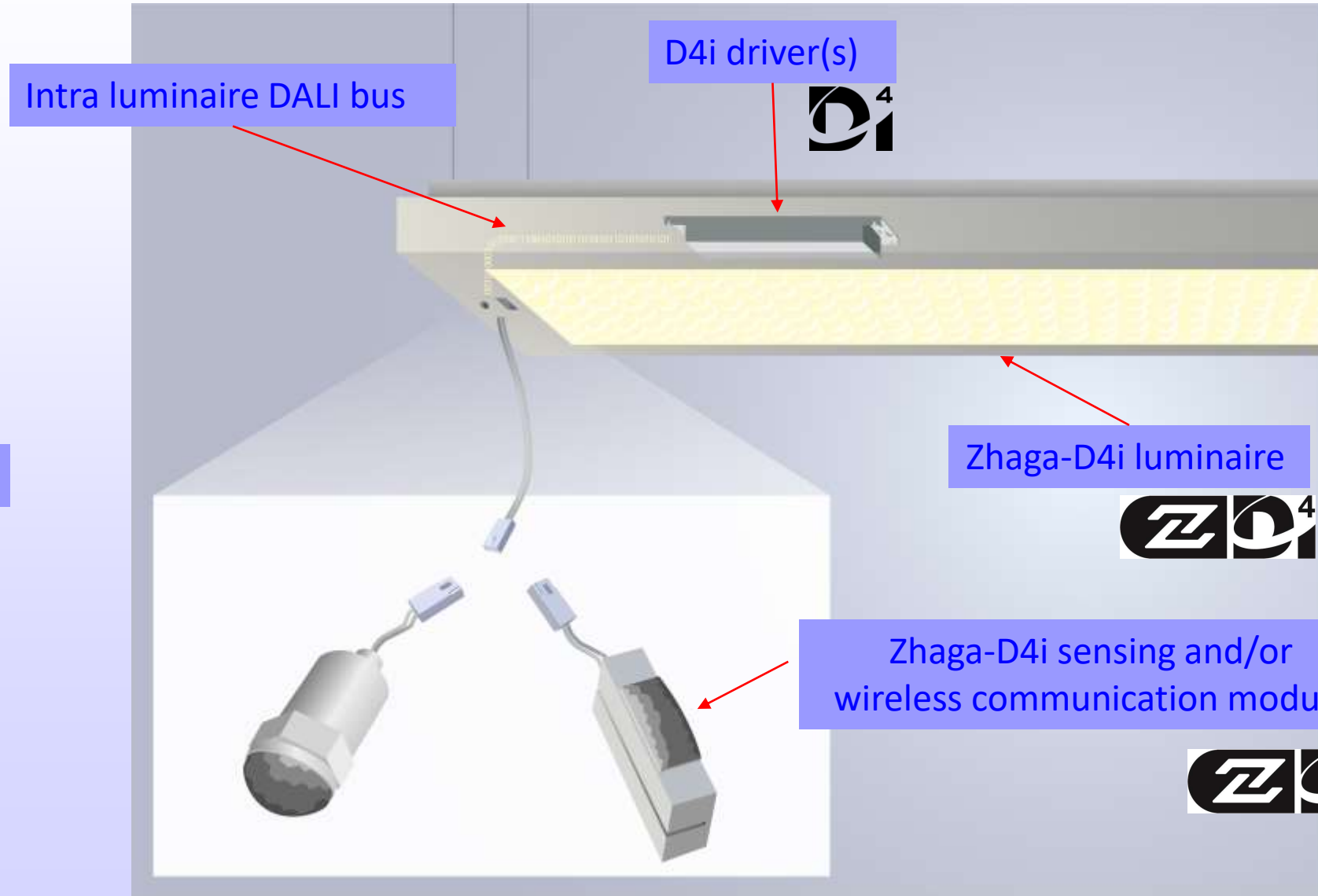

Zhaga connectors



Zhaga-D4i Certification – Summary



Zhaga and DALI Alliance have developed a joint certification program for indoor luminaires, which is based on a standardised interface between drivers, luminaires and sensing/communication modules.

Zhaga-D4i certified luminaires will be the backbone of intelligent building management and more.

- It creates a simple way of adding control/ sensing modules into the building system architecture.
- A large ecosystem of modules will be available for Zhaga certified luminaires.
- It allows selection of luminaires today for the technology advances that control and sensing modules will bring tomorrow.
- Adding the requirement of Zhaga-D4i certification simplifies tender processes
 - The certification provides an assurance of interoperability and gives confidence that the different parts of the system will operate together.
 - All Zhaga-D4i certified products can be traced through an easy accessible database on the Zhaga website.

Certification Process: Book 20 Zhaga-D4i Luminaires

Organization

Process

Comment



Associate or regular membership of Zhaga is required



Compile required documentation and submit to Zhaga Test Centre

Tested for compliance against Zhaga specifications

Product awarded Zhaga-D4i certification and use of Zhaga and D4i logos

Certification Process: Book 20 Zhaga Components

Organization

Process

Comment

Associate or regular membership of Zhaga is required

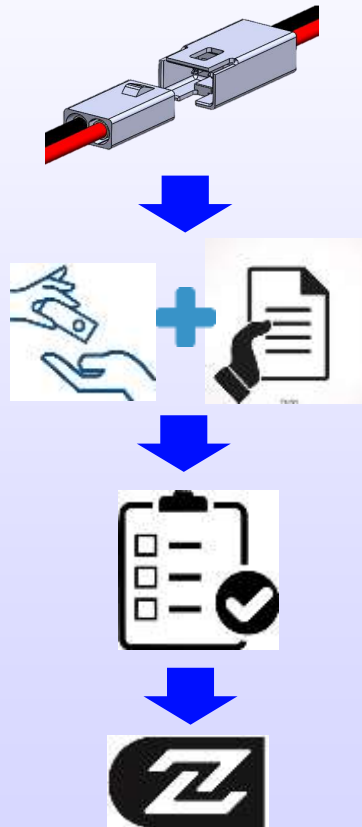

Compile required documentation and sample and submit to Zhaga Test Centre

Tested for compliance against Zhaga specifications

Product awarded Zhaga certification and use of the Zhaga logo

Certification Process: Book 20 Zhaga-D4i Module

Organization

Process

Comment

Associate or regular membership of DALI Alliance is required



Associate or regular membership of Zhaga is required



Product self tested or tested by DALI Alliance test house

Submit results to the DALI Alliance for verification and D4i certification.

Compile required documentation and submit to Zhaga Test Centre

Tested for compliance against Zhaga specifications

Product awarded Zhaga-D4i certification and use of Zhaga and D4i logos

Zhaga Book 20 Video

- The Zhaga Consortium has recently produced a video which provides a summary of the features and benefits of the Zhaga Book 20 interface.
- The video can be viewed by following the below link:
- <https://youtu.be/qAF4FymbUJw>

Thank you

For further information, please contact

Dee Denteneer, Secretary General, secgen@zhagastandard.org

Axel Baschnagel, Marketing Communications, marcom@zhagastandard.org



Q&A

- Paul Drosihn, General Manager DALI Alliance
- Gabe Arnold, PNNL/DoE
- Scott Wade, Technical Manager DALI Alliance
- Adrian Green, Amphenol

- Contacts:
 - info@DALI-Alliance.org
 - info@zhagastandard.org
 - LPrize@nrel.gov